

MÉXICO
2010
Bicentenario Centenario
Independencia Revolución

Búsquedas de Información Tecnológica





GOBIERNO
FEDERAL

SE



MÉXICO 2010

Bicentenario Independencia
Centenario Revolución

¿Qué es una patente?

Una patente es un título legal que protege una invención por un tiempo limitado, que en México es de 20 años.

La patente habilita a su propietario para excluir a otros de la explotación de la invención dentro del territorio en el que fue concedida.

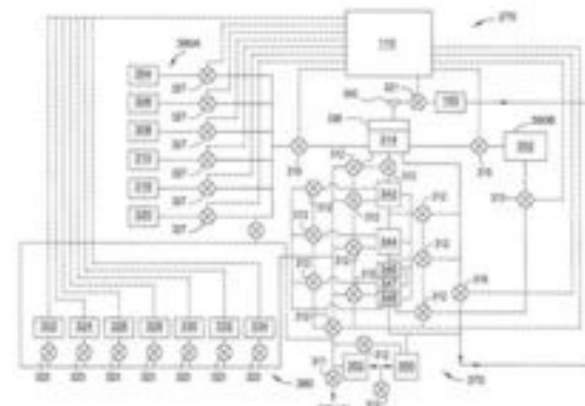
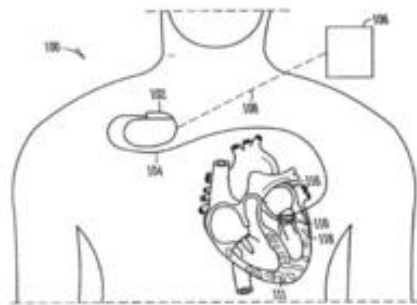



GOBIERNO
FEDERAL

SE



MÉXICO 2010

Bicentenario Independencia
Centenario Revolución

¿Qué elementos componen una patente?

Datos Bibliográficos

Una **primera página** que contiene la información **bibliográfica** como el **título de la invención**, el **nombre del inventor**, el **resumen** de la invención, etc.

Información Técnica

Una **descripción** detallada de la invención, que es la información **técnica** indicando cómo está construida, cómo se usa y qué beneficios ofrece comparada con otras invenciones existentes.

Las **reivindicaciones** las cuales son una clara y concisa definición de lo que la patente protege legalmente.

Los **dibujos** que sirven de apoyo a la información **técnica**.

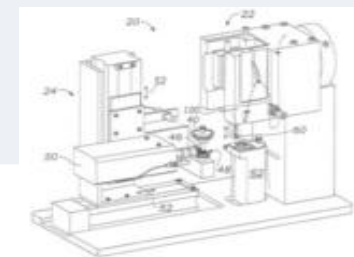



GOBIERNO
FEDERAL

SE



MÉXICO 2010

Bicentenario Independencia
Centenario Revolución

¿Qué es la Información Tecnológica de Patentes?

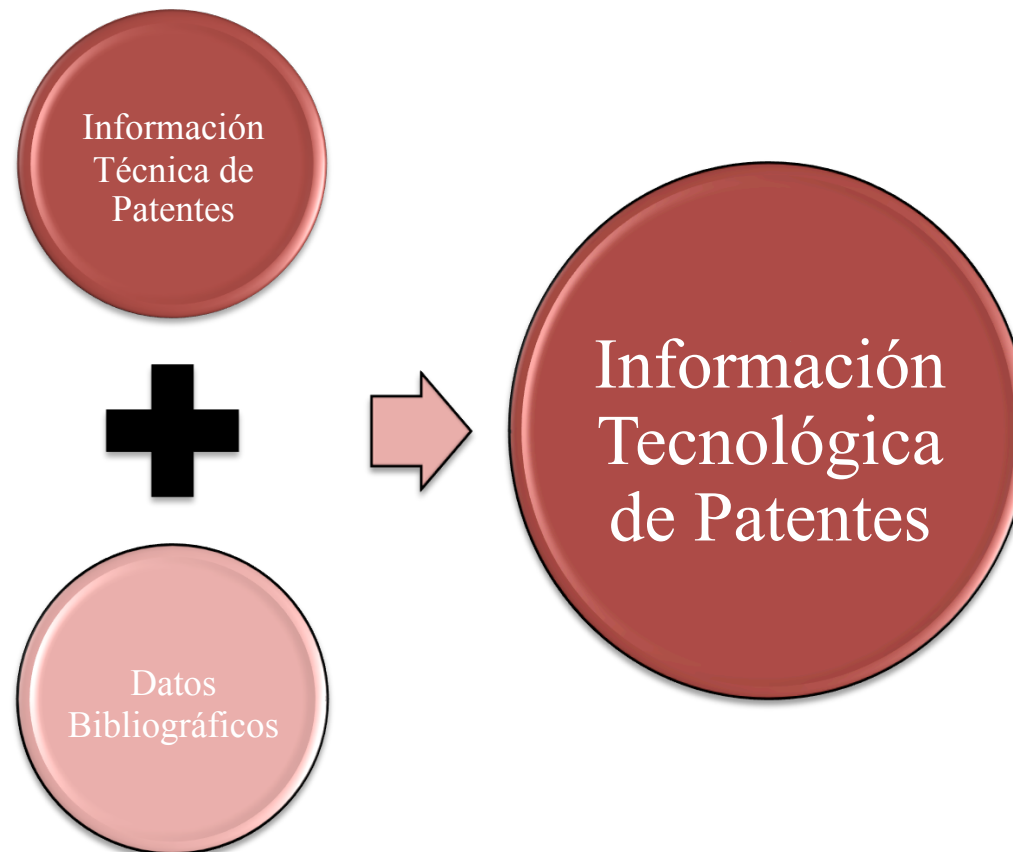

¿Por qué realizar búsquedas?

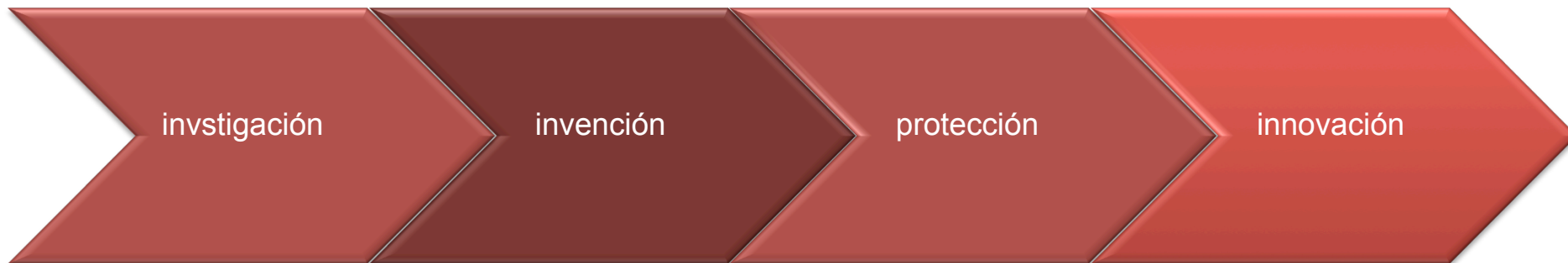



GOBIERNO
FEDERAL

SE



MÉXICO 2010

Bicentenario Independencia
Centenario Revolución

Fuentes de Información existentes

- Libros
- Tesis académicas

- Revistas
- Publicaciones especializadas

- Contacto con otros técnicos

- Exposiciones
- Congresos

- **Documentos de Patentes**



**GOBIERNO
FEDERAL**

SE



MÉXICO 2010

Bicentenario Independencia
Centenario Revolución

www.uspto.gov

Periférico Sur #3106 Col. Jardines del Pedregal
C.P. 01900, México, D.F.



**GOBIERNO
FEDERAL**

SE



MÉXICO 2010

Bicentenario Independencia
Centenario Revolución

Ejercicios de búsqueda

Ejercicio # 1.

Información a buscar: Válvulas de corazón con alerones flexibles

1. Seleccionar las palabras claves relacionadas con el uso, propósito y composición de la invención
2. Buscar la palabra en el índice de clasificación de patentes de Estados Unidos
3. Verificar la relevancia de las clases y subclases de la clasificación
4. Leer las definiciones de la clasificación para verificar el alcance de las subclases
5. Buscar en las bases de datos las patentes otorgadas y las solicitudes publicadas.
6. Revisar las reivindicaciones, especificaciones y dibujos de los documentos relevantes recuperados
7. Checar todas las referencias y notas de la clasificación de Estados Unidos y los campos de búsqueda para investigar clase y subclases adicionales



GOBIERNO FEDERAL

SE



MÉXICO 2010

Bicentenario Independencia Centenario Revolución

Página principal de la USPTO



The screenshot shows the USPTO website homepage. At the top, there is a navigation bar with links for Home, Help, Site Index, and Contact Us. Below this is a search bar and a dropdown menu for 'HOW DO I:'. The main navigation menu includes About USPTO, Patents, Trademarks, IP Law & Policy, Products & Services, Careers, Inventors, and News & Notices. A secondary menu includes eBusiness/Alerts, FAQs, and For Kids. The main content area features a 'USPTO Closed February 8-11' announcement with a photo of the USPTO building and a 'Read More' link. To the right is a 'USPTO Self Service' section with a dropdown for 'Information Services and Data Products'. Below these are three columns of links: Patents, Trademarks, and Intellectual Property Law & Policy. A red arrow points from the left towards the Patents section.

United States Patent and Trademark Office
An Agency of the Department of Commerce

Home | Help | Site Index | Contact Us

SEARCH: GO

HOW DO I: - Select an Option - GO

About USPTO Patents Trademarks IP Law & Policy Products & Services Careers Inventors News & Notices

eBusiness/Alerts FAQs For Kids

USPTO Closed February 8-11

The federal government in the Washington, D.C., metropolitan area is closed today, February 11. Click the link below for more information.

» [Read More](#)

USPTO Self Service

Information Services and Data Products:
- Select a Product or Service - GO

Patents

- Patents Process**
Visit the Patent Basics page
- Search**
Search the Patent Full-Text and Image Database (PatFT)
- View Fee Schedule**
Check on the current fees and information related to the patent process
- File Online**
Apply for a patent using the Electronic Filing System (EFS-Web)
- Check Status**
Check the status via the Patent Application Information Retrieval (PAIR) system
- Maintain/Pay Fees**
Pay your maintenance fees online
- Appeal**
Learn the appeal process via the Board of Patent Appeals and Interferences (BPAI)
- Assign Ownership**
via the Electronic Patent Assignment System (EPAS)
- Web Tools**
Get web application links & help via the Electronic Business Center (EBC)

Trademarks

- Trademark Basics**
View Basic Information about Trademarks
- Search Marks**
Search pending and registered marks (TESS)
- File Forms Online**
File application and other documents online (TEAS)
- Check Status**
Check the status of an application or registration (TARR)
- View and Order Documents**
View and download application and registration records (TDR) and order certified copies
- Maintain/Renew a Registration**
File documents to keep a registration active
- View Fee Schedule**
Check the current trademark fees
- Trademark Trial and Appeal Board**
Visit TTAB Home Page
- Assignments**
Visit Assignments Home Page
- Madrid Protocol**

» [More about Trademarks](#)

Intellectual Property Law & Policy

- IP Policy and Enforcement**
USPTO leads efforts to develop and strengthen both domestic and international IP protection
- Training and Education**
The Global IP Academy (GIPA) offers IP related programs around the world
- Boards and Counsel**
General Counsel, Office of the Solicitor, Office of General Law, Office of Enrollment and Discipline, Board of Patent Appeals and Interferences, and Trademark Trial and Appeal Board
- Interested in Copyrights?**
The USPTO advises the Administration on copyright protection and policy
- Protecting Intellectual Property**
Strategy Targeting Organized Piracy (STOP!) helps businesses protect their IP at home and abroad
- Rulemaking**
The USPTO continues to propose new initiatives to make its operations more efficient

Periférico Sur #3106 Col. Jardines del Pedregal
C.P. 01900, México, D.F.



GOBIERNO
FEDERAL

SE



MÉXICO 2010

Bicentenario Independencia
Centenario Revolución

Sección de búsqueda de patentes



UNITED STATES PATENT AND TRADEMARK OFFICE
An Agency Of The United States Department Of Commerce

Patent Full-Text and Full-Page Image Databases

[Important Notices and Policies -- Please Read!](#)

PATFT: Issued Patents

Full-text since 1976; full-page images since 1790.

[Quick Search](#)
[Advanced Search](#)
[Patent Number Search](#)

[View Patent Full-Page Images](#)

[Status and Event History](#)
[Database Contents](#)
[Help Files](#)

[Report Data Errors](#)
[Report Problems](#)

[How to Access and View Full-Page Images](#)

AppFT: Patent Applications

Published since March, 2001.

[Quick Search](#)
[Advanced Search](#)
[Publication Number Search](#)

[View Publication Full-Page Images](#)

[Status and Event History](#)
[Help Files](#)

[Report Data Errors](#)
[Report Problems](#)

Related USPTO Resources

[Searching by Patent Classification](#)
[Patent Application Information Retrieval \(PAIR\)](#)
[Patent Assignment Database](#)
[Patent Attorneys and Agents](#)
[Published Sequence Listings](#)

2 Last Modified: 12/4/2009

Periférico Sur #3106 Col. Jardines del Pedregal
C.P. 01900, México, D.F.



GOBIERNO FEDERAL

SE



MÉXICO 2010

Bicentenario Independencia Centenario Revolución

Índice de clasificación de patentes de la USPTO

United States Patent and Trademark Office PATENTS

Home | Site Index | Search | FAQ | Glossary | Guides | Contacts | eBusiness | eBiz alerts | News | Help

Patents > Guidance, Tools, and Manuals > Classification > Index to the USPC

Class Numbers & Titles | Class Numbers Only | USPC Index | International | HELP | Office of Patent Classification

Index to the USPC

Index to the United States Patent Classification (USPC) System

Select the format and section (by letter) ...

Index in HTML A B C D E F G **H** I J K L M N O P Q R S T U V W X Y Z

Index in PDF A B C D E F G H I J K L M N O P Q R S T U V W X Y Z

KEY: =online business system =fees =forms =help =laws/regulations =definition (glossary)

The Inventors Assistance Center is available to help you on patent matters. Send questions about USPTO programs and services to the USPTO Contact Center (UCC). You can suggest USPTO webpages or material you would like featured on this section by E-mail to the webmaster@uspto.gov. While we cannot promise to accommodate all requests, your suggestions will be considered and may lead to other improvements on the website.

| HOME | SITE INDEX | SEARCH | eBUSINESS | HELP | PRIVACY POLICY

Last Modified: 10/30/2006 10:19:10

Heart

Artificial	623 / 3.1
Artery	623 / 1.1
Valve	623 / 2.1
Energized magnet actuator	251 / 65
Motor operated by motivating ...	60 / 516
Mass	60 / 516
Pivoted, line condition	137 / 527
Change responsive	137 / 527
Cardiac assist device	600 / 16+
Expansible chamber pump	417 / 472
Heart cam, register	235 / 144 HC
Heart-lung digest	128 / DIG 3
Pacemaker	607 / 9+
Shaped packaging	D09 / 629

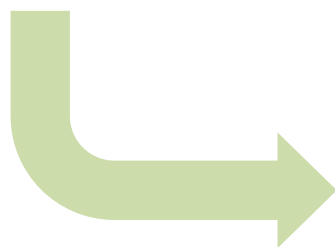

Periférico Sur #3106 Col. Jardines del Pedregal
C.P. 01900, México, D.F.



Equivalencia con la clasificación internacional de patentes

CLASS 623 PROSTHESIS (I.E., ARTIFICIAL BODY MEMBERS), PARTS THEREOF, OR AIDS AND ACCESSORIES THEREFOR 623 - 1

1.1	ARTERIAL PROSTHESIS (I.E., BLOOD VESSEL)	1.47	...Collagen
1.11	..Stent combined with surgical delivery system (e.g., surgical tools, delivery sheath, etc.)	1.48	...Protein
1.12	..Expandable stent with constraining means	1.49	..Made of synthetic material
1.13	..Stent in combination with graft	1.5	..Knitted
1.14	..Stent penetrating natural blood vessel	1.51	..Woven
1.15	..Stent structure	1.52	...Velour surface
1.16	..Having multiple connected bodies	1.53	...Braided
1.17	..Stent length remains constant with lateral expansion	1.54	..Fiber
1.18	..Having shape memory	2.1	HEART VALVE
1.19	...Temperature responsive	2.11	..Combined with surgical tool
1.2	..Self-expanding stent	2.12	..Flexible leaflet
1.21	..Formed inside natural blood vessel	2.13	..Leaflet made of biological tissue
1.22	..Helicallly wound	2.14	...Supported by resilient frame
1.23	..Including means for graft delivery (e.g., delivery sheath, ties, threads, etc.)	2.15	...Trileaflet
1.24	..Including valve	2.16	..Bileaflet
1.25	..Inflatable graft	2.17	..Supported by frame
1.26	..Heart valve	2.18	..Resilient frame
1.27	..Having plurality of parallel lumens	2.19	...Trileaflet
1.28	..Having pleats	2.2	..Having rigid or semirigid pivoting occluder
1.29	..Longitudinal pleats	2.21	..Fixed cylindrical pin structured to permit only pivoting movement of occluder
1.3	..Having variable diameter	2.22	..Annular support member includes projecting means for guiding occluder's pivoting motion
1.31	..Enlarged end	2.23	...Strut projecting means
1.32	..Having built-in reinforcement	2.24	...Strut projecting means extends through hole in occluder
1.33	..Monofilament	2.25	...Strut projecting means cooperates with depression portion of occluder to guide pivoting movement
		2.26	...Occluder also includes guiding



U.S. CLASS 623 PROSTHESIS (I.E., ARTIFICIAL BODY MEMBERS), PARTS THEREOF, OR AIDS AND ACCESSORIES THEREFOR

1.1-1.54	A 61 F	2 / 06
2.1-2.42	A 61 F	2 / 24
3.1-3.3	A 61 M	1 / 10
4.1-5.16	A 61 F	2 / 14
6.11-6.64	A 61 F	2 / 16
7	A 61 F	2 / 52
8	A 61 F	2 / 12
9	A 61 F	2 / 20
10	A 61 F	2 / 18
11.11	A 61 F	2 / 02
13.11-14.13	A 61 F	2 / 08
15.11-15.12	A 61 F	2 / 10
16.11	A 61 F	2 / 28
17.11-17.16	A 61 F	2 / 44
17.17-17.19	A 61 F	2 / 02
18.11-18.12	A 61 F	2 / 30
19.11-19.14	A 61 F	2 / 40
20.11-20.36	A 61 F	2 / 38
21.11-21.19	A 61 F	2 / 42
22.11-22.46	A 61 F	2 / 32
23.11-23.38	A 61 F	2 / 36
23.39-23.46	A 61 F	2 / 30
23.47-23.63	A 61 F	2 / 28
23.64-23.71	A 61 F	2 / 04
23.72-23.76	A 61 F	2 / 02
24	A 61 F	2 / 48
25	A 61 F	2 / 70
26	A 61 F	2 / 72
27	A 61 F	2 / 74
28	A 61 F	2 / 60
29	A 61 F	2 / 60

Clase 623 Prótesis

 **United States Patent and Trademark Office** PATENTS

[Home](#) | [Site Index](#) | [Search](#) | [FAQ](#) | [Glossary](#) | [Guides](#) | [Contacts](#) | [eBusiness](#) | [eBiz alerts](#) | [News](#) | [Help](#)

[Patents](#) > [Guidance, Tools, and Manuals](#) > [Classification](#) > [Class Schedule](#)

[Class Numbers & Titles](#) | [Class Numbers Only](#) | [USPC Index](#) | [International](#) | [HELP](#)













You are viewing a USPC Schedule.

Class 623 PROSTHESIS (I.E., ARTIFICIAL BODY MEMBERS), PARTS THEREOF, OR AIDS AND ACCESSORIES THEREFOR

[Click here for a printable version of this file](#)

Turn Outline OFF

Select Largest Indent Level to be Displayed

- +  1.1 **ARTERIAL PROSTHESIS (I.E., BLOOD VESSEL)**
- +  2.1 **HEART VALVE**
- +  3.1 **CORPOREAL ARTIFICIAL HEART, HEART ASSIST (E.G., IMPLANTABLE BLOOD PUMP, ETC.), CONTROL REGULATOR, OR POWER SUPPLY THEREFOR, OR METHOD OF OPERATION THEREFOR**
- +  4.1 **EYE PROSTHESIS (E.G., LENS OR CORNEAL IMPLANT, OR ARTIFICIAL EYE, ETC.)**
- +  7 **BREAST PROSTHESIS**
- +  9 **LARYNX, TRACHEA, TRACHEOBRONCHIAL PROSTHESIS OR COMBINATION THEREOF**
- +  10 **EAR OR NOSE PROSTHESIS**
- +  11.11 **IMPLANTABLE PROSTHESIS**
- +  24 **HAVING ELECTRICAL ACTUATOR**
- +  26 **HAVING FLUID ACTUATOR**
- +  27 **LEG**
- +  57 **ARM OR COMPONENT (E.G., ELBOW, WRIST, HAND, FINGER, ETC.) AND ACTUATOR OR CONNECTOR THEREFOR**
- +  66.1 **MISCELLANEOUS**



GOBIERNO
FEDERAL

SE



MÉXICO 2010

Bicentenario Independencia
Centenario Revolución

ARBOL: Clase 623 Prótesis

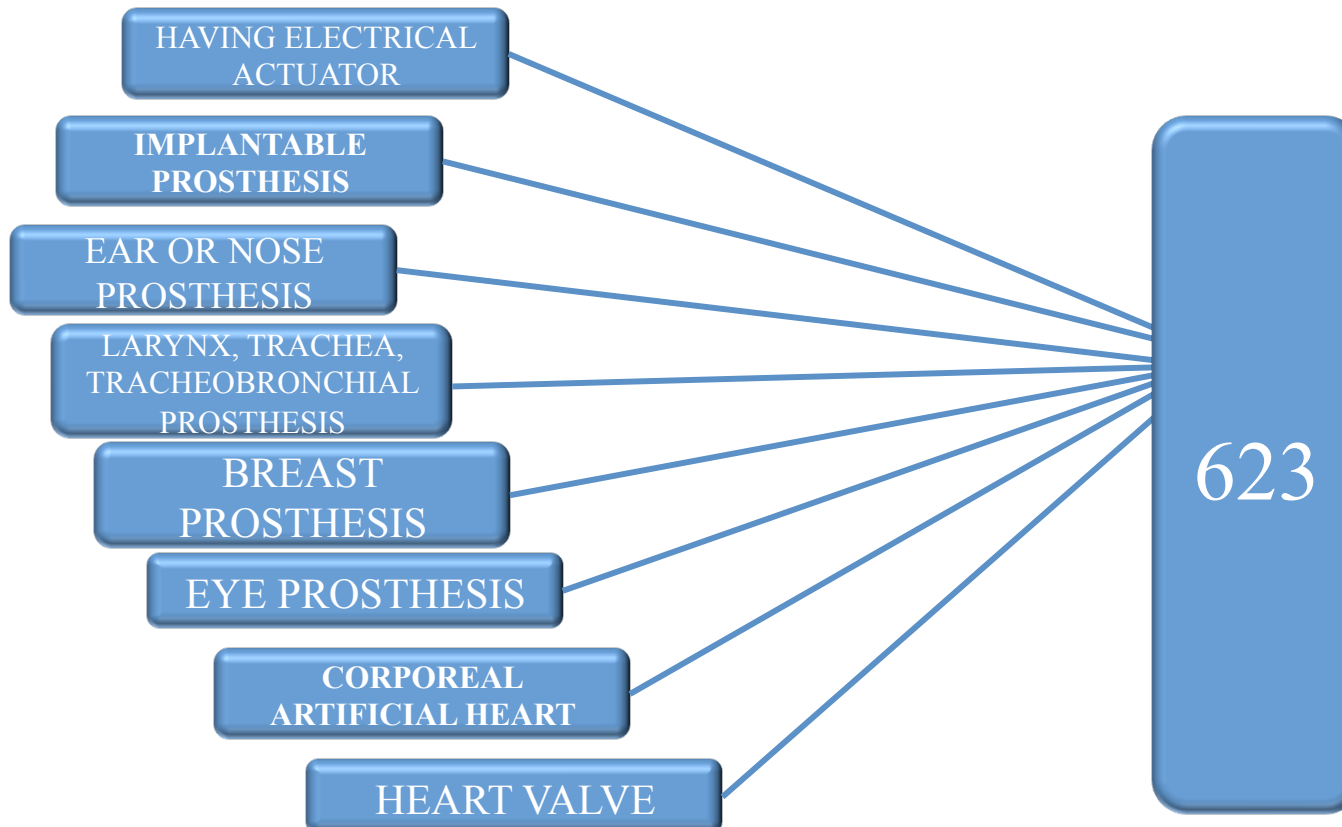
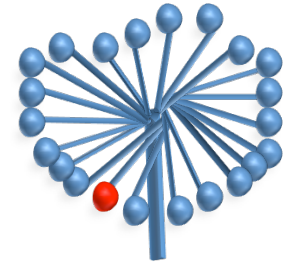



ARBOL: Subclase 2 "Heart valve"

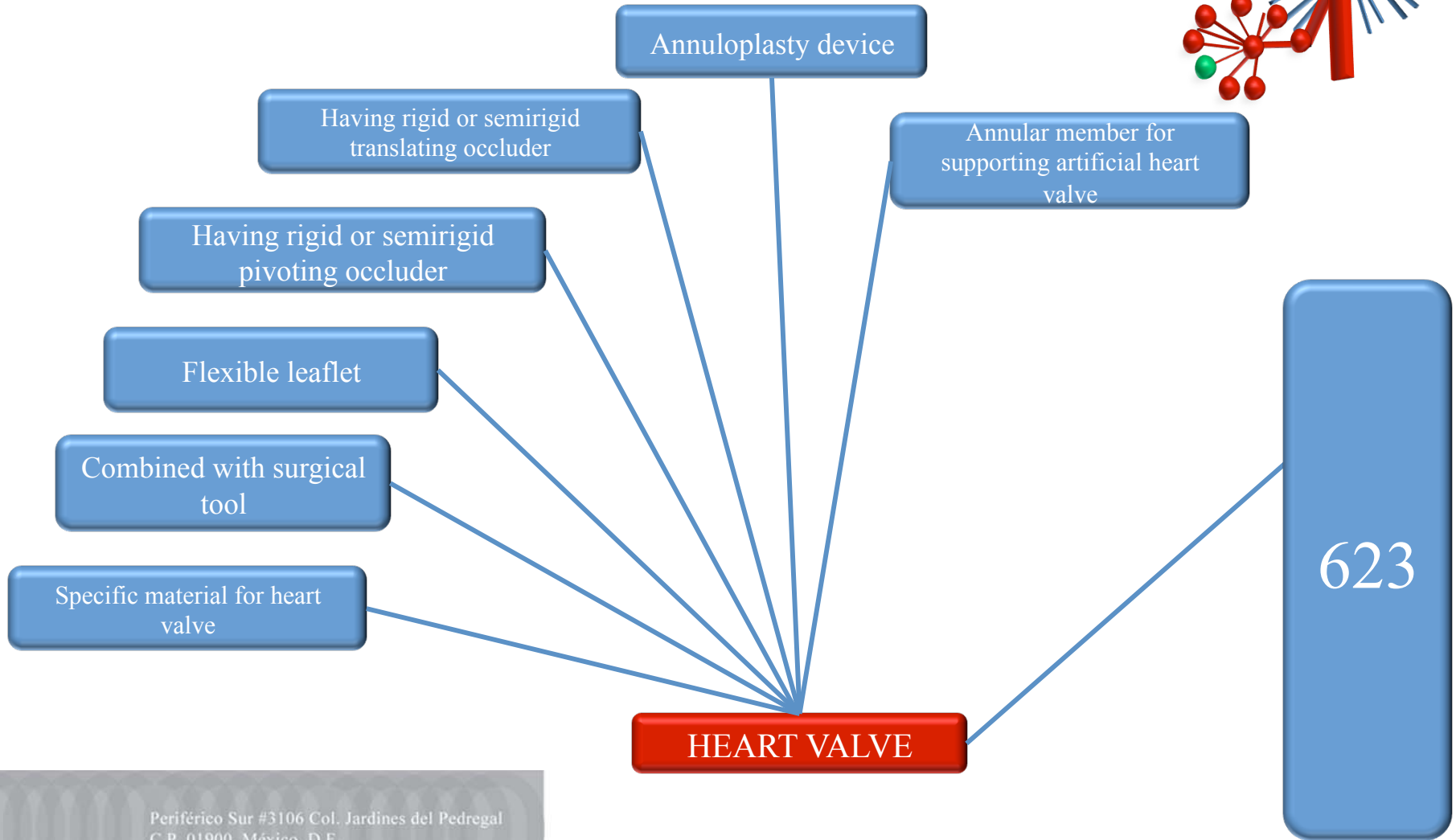
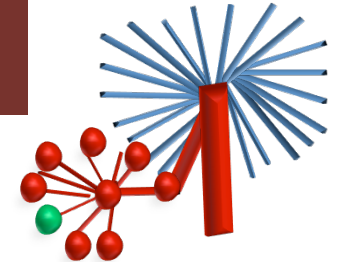



GOBIERNO FEDERAL

SE



MÉXICO 2010

Bicentenario Independencia Centenario Revolución



US007004176B2

(12) United States Patent Lau

(10) Patent No.: US 7,004,176 B2 (45) Date of Patent: Feb. 28, 2006

(54) HEART VALVE LEAFLET LOCATOR (75) Inventor: Jan Lau, Windsor, CA (US) (73) Assignee: Edwards Lifesciences AG, Saint-Prex (CH) (*) Notice: Subject to any disclaimer, the term of this patent is extended or adjusted under 35 U.S.C. 154(h) by 0 days. (21) Appl. No.: 10/688,712 (22) Filed: Oct. 17, 2003

5,593,442 A 1/1997 Klein 5,607,444 A 3/1997 Lau 5,674,280 A 10/1997 Davidson et al. 5,713,949 A 2/1998 Jayaraman 5,741,274 A 4/1998 Lesker et al. 5,817,126 A 10/1998 Inman 5,824,071 A 10/1998 Nelson et al. 5,876,419 A 3/1999 Carpenter et al. 5,911,732 A 6/1999 Hojebane 5,919,233 A 7/1999 Knopf et al. 5,980,552 A 11/1999 Pinchasik et al. 6,027,525 A 2/2000 Suh et al. 6,071,292 A 6/2000 Makower et al. 6,093,203 A 7/2000 Ullacker

(65) Prior Publication Data US 2005/0085903 A1 Apr. 21, 2005

(Continued) FOREIGN PATENT DOCUMENTS DE 196 05 042 A1 1/1998

(51) Int. Cl. A61B 19/00 (2006.01) A61B 18/18 (2006.01) A61F 2/24 (2006.01) (52) U.S. Cl. 128/898; 623/2.12; 600/14; 606/114 (58) Field of Classification Search 128/898; 623/2.12, 904; 606/113, 114, 127; 600/13-16 See application file for complete search history.

(Continued) OTHER PUBLICATIONS Bochenek, K.M., Anny, J.E., Tal, M.G., "Right Atrial Migration and Percutaneous Retrieval of a Gunther Tulip Inferior Vena Cava Filter," J. Vasc. Interv. Radiol. 2003, 14, 1207-1209.

(56) References Cited U.S. PATENT DOCUMENTS 4,164,046 A 8/1979 Cooley 4,655,771 A 4/1987 Wallsten 4,954,126 A 9/1990 Wallsten 5,006,106 A 4/1991 Angelchik 5,061,275 A 10/1991 Wallsten et al. 5,064,435 A 11/1991 Porter 5,104,404 A 4/1992 Wolff 5,163,955 A 11/1992 Love et al. 5,170,802 A 12/1992 Mehra 5,383,892 A 1/1995 Cardon et al. 5,476,471 A 12/1995 Shifrin et al. 5,534,007 A 7/1996 St. Germain et al. 5,571,135 A 11/1996 Fraser et al. 5,584,879 A 12/1996 Reinold et al.

(Continued) Primary Examiner—David J. Isabella (74) Attorney, Agent, or Firm—David L. Hauser (57) ABSTRACT

Disclosed are methods and devices for determining valve leaflet orientation. A catheter is provided with a conformable, radiopaque target. The target is deployed within a valve, such as the mitral valve. The conformable target conforms to the coaptation axis in response to closing of the valve leaflets. That coaptation axis may then be visualized, and utilized to determine information about valve operation, or to assist in placement of devices in the vicinity of the valve.

12 Claims, 51 Drawing Sheets

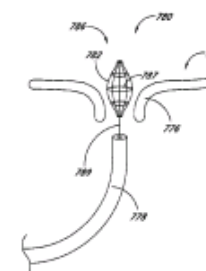
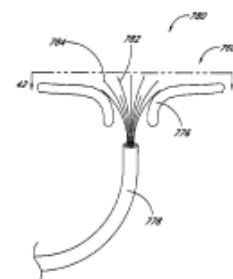



**GOBIERNO
FEDERAL**

SE



MÉXICO 2010

Bicentenario Independencia
Centenario Revolución

ep.espacenet.com

Periférico Sur #3106 Col. Jardines del Pedregal
C.P. 01900, México, D.F.

Ejercicios de búsqueda

Ejercicio # 2.

Información a buscar: Cama para hospital con retrete integrado. Usar ESPACENET.



The screenshot shows the ESPACENET website interface. On the left, there is a navigation menu with the following sections:

- Quick Search**: Search with keywords, or for persons or organisations
- Advanced Search**: Search using any of the available fields
- Number Search**: Search using publication, application, priority or NPL reference number
- Classification Search**: Browse or search the Classification System of the European Patent Office

The main content area displays "espacenet - NEWS," with a search bar and a "Search" button. Below the search bar, there is an example search: "Example: Siemens EP 2007" with an explanation of Smart Search. The page also features a "News Flashes" section with "Scheduled maintenance" and "Current issues" notices, and a "Latest Updates" section listing patent numbers like DE112008001324 and ES2332767.



GOBIERNO
FEDERAL

SE



MÉXICO 2010

Bicentenario Independencia
Centenario Revolución

Search the European classification

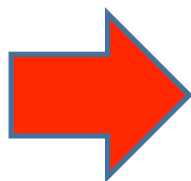

Find classification(s) for keywords **syringe injection**

[Index](#) [A](#) [B](#) [C](#) [D](#) [E](#) [F](#) [G](#) [H](#) [Y](#) Next: [A](#)

HUMAN NECESSITIES	A	<input type="checkbox"/>
PERFORMING OPERATIONS; TRANSPORTING	B	<input type="checkbox"/>
CHEMISTRY; METALLURGY	C	<input type="checkbox"/>
TEXTILES; PAPER	D	<input type="checkbox"/>
FIXED CONSTRUCTIONS	E	<input type="checkbox"/>
MECHANICAL ENGINEERING; LIGHTING; HEATING; WEAPONS; BLASTING ENGINES OR PUMPS	F	<input type="checkbox"/>
PHYSICS	G	<input type="checkbox"/>
ELECTRICITY	H	<input type="checkbox"/>
GENERAL TAGGING OF NEW TECHNOLOGICAL DEVELOPMENTS[N0403]	Y	<input type="checkbox"/>

show notes



Search the European classification

Find classification(s) for keywords **syringe injection**

[Index](#) [A](#) [B](#) [C](#) [D](#) [E](#) [F](#) [G](#) [H](#) [Y](#)

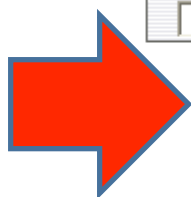

- ■ ■ **Beds specially adapted for nursing; Devices for lifting disabled persons** (A61F5/045 takes precedence; stretchers with facilities for pic... [A61G7](#)
- **Appliances for aiding disabled persons to walk about**(apparatus for helping babies to walkA47D13/04;[N: orthopaedic devices for correcting deformities of, or supporting, limbsA61F5/01D]; exe... [A61H3](#)
- **Weighing apparatus or methods adapted for special purposes not provided for in the preceding groups** [N: (electric measuring arrangements involving comparison with a reference value [G01G19](#)
- **Stuffed or fluid mattresses specially adapted for chairs, beds or sofas**(arrangements for preventing bed-sores or for supporting patients with burns, e.g. mattresses specially adapted theref... [A47C27](#)
- **Accommodation for nursing, e.g. in hospitals, not covered by any preceding group of this subclass, e.g. trolleys for transport of medicaments or food** (service or tea-tables, trolleys or wag... [A61G12](#)
- **Devices or systems using a string or strip of light sources** [N0108] [F21S4](#)
- **Bed-pans, urinals or other sanitary devices for bed-ridden persons; Cleaning devices therefor, e.g. combined with toilet-urinals** (urinals worn by the patient [A61G9](#)
- **Sanitary or other accessories for lavatories** (hand tools for cleaning the toilets bowl A47K11/10; seats or covers for closets [E03D9](#)
- **Signalling systems according to more than one of groups G08B3/00 to G08B6/00** (combina... [G08B7](#)
- **Arrangements of electric circuit elements in or on lighting devices** (electric circuits per se H05B39/00) [F21V23](#)



GOBIERNO FEDERAL

SE



MÉXICO 2010

Bicentenario Independencia Centenario Revolución

HUMAN NECESSITIES	A	<input type="checkbox"/>
MEDICAL OR VETERINARY SCIENCE; HYGIENE	A61	<input type="checkbox"/>
TRANSPORT OR ACCOMODATION FOR PATIENTS; OPERATING TABLES OR CHAIRS; CHAIRS FOR DENTISTRY; FUNERAL DEVICES (chairs or beds in general A47C; walking aids A61H3/00)	A61G	<input type="checkbox"/>
Invalid beds or accessories; Treatment rooms for medical purposes; Accommodation for nursing		
Beds specially adapted for nursing; Devices for lifting disabled persons (A61F5/045 takes precedence; stretchers with facilities for picking up disabled persons A61G1/003) [C0607]	A61G7	<input type="checkbox"/>
	A61G7/00	<input type="checkbox"/>

<input type="checkbox"/> show notes	Copy to searchform: <input type="text"/>	Copy	Clear
→ [N: Means for bathing bedridden persons]	A61G7/00B	<input type="checkbox"/>	
→ [N: with means for turning-over the patient]	A61G7/00D	<input type="checkbox"/>	
→ [N: having means for attaching a cabinet in order to transport bed and cabinet together]	A61G7/00E	<input type="checkbox"/>	
→ having adjustable mattress frame	A61G7/002	<input type="checkbox"/>	
→ tiltable around transverse horizontal axis, e.g. for Trendelenburg position [N: (rocking beds for physical therapy A61H1/00C2; hanging patient inclined downwardly for drawing him out A61H1/02D2)] [C9809]	A61G7/005	<input type="checkbox"/>	
→ tiltable around longitudinal axis, e.g. for rolling	A61G7/008	<input type="checkbox"/>	
→ raising or lowering of the whole mattress frame (A61G7/005, A61G7/008 take precedence)	A61G7/012	<input type="checkbox"/>	
→ divided into different adjustable sections, e.g. for Gatch position	A61G7/015	<input type="checkbox"/>	
→ Control or drive mechanisms	A61G7/018	<input type="checkbox"/>	
→ with toilet conveniences, or specially adapted for use with toilets	A61G7/02	<input type="checkbox"/>	
→ Beds for special sanitary purposes, [N: e.g. for giving enemas, irrigations, flushings (A61G7/02 takes precedence; means for bathing bed-ridden persons A61G7/00B)]	A61G7/047	<input type="checkbox"/>	
→ Parts, details or accessories of beds (devices for prevention against falling out A47C21/08, A47D7/00; [N: mattresses A47C27/00])	A61G7/05	<input type="checkbox"/>	
→ [N: Bed-clothes supports to alleviate the weight of the bed-clothes on the patient (bed cover holders A47C21/02)]	A61G7/05B	<input type="checkbox"/>	
→ [N: Dispensers of disposable sheets]	A61G7/05D	<input type="checkbox"/>	
→ [N: Holders, support devices for receptacles, e.g. for drainage or urine bags (hanging-up devices for infusion A61M5/14R6)]	A61G7/05H	<input type="checkbox"/>	
→ [N: Harnesses or restraining devices in order to evacuate a patient with the mattress, e.g. in situations of emergency, disaster or fire (restraining in general A61F5/37)]	A61G7/05K	<input type="checkbox"/>	
→ Aids for getting into, or out of, bed, e.g. steps, chairs, [N: cane-like supports]	A61G7/053	<input type="checkbox"/>	
→ [N: Lifting poles]	A61G7/053B	<input type="checkbox"/>	
→ [N: Lifting straps, usually attached to the bed-end and grasped by the patient in order to raise himself into a sitting position]	A61G7/053D	<input type="checkbox"/>	
→ Arrangements for preventing bed-sores or for supporting patients with burns, e.g. mattresses specially adapted therefor [N: (ventilation openings in mattresses A47C21/04B; pneumatic or hydraulic mattresses A47C27/08)] [C9812]	A61G7/057	<input type="checkbox"/>	
→ [N: with integral, body-bearing projections or protuberances] [C9410]	A61G7/057A	<input type="checkbox"/>	
→ [N: with modular blocks, or inserts, with layers of different material]	A61G7/057C	<input type="checkbox"/>	





**GOBIERNO
FEDERAL**

SE



MÉXICO 2010

Bicentenario Independencia
Centenario Revolución

www.ipdl.inpit.go.jp/homepg_e.ipdl

Periférico Sur #3106 Col. Jardines del Pedregal
C.P. 01900, México, D.F.



**GOBIERNO
FEDERAL**

SE



MÉXICO 2010

Bicentenario Independencia
Centenario Revolución

PAJ (PATENT ABSTRACTS OF JAPAN)

IPDL Industrial Property
Digital Library

National Center for
Industrial Property
Information and Training
INPIT

[INPIT Home Page](#) [JPO Home Page](#) [To Japanese Page](#)

The Industrial Property Digital Library (IPDL) offers the public access to IP Gazettes of the JPO free of charge through the Internet.

Access Total :
4,116,679

→ Patent&Utility Model

[Patent & Utility Model Gazette DB](#)
[Patent & Utility Model Concordance](#)
[FI/term Search](#)
[PAJ](#)
[Patent Map Guidance](#)

→ Trademark

[Japanese Trademark Database](#)
[Japanese Figure Trademarks](#)
[Japanese Well-Known Trademark](#)
[List of Goods and Services](#)

→ Design

[Design Gazette DB](#)

→ Database Contents

[Patent & Utility Model Gazette DB](#)
[Patent & Utility Model Concordance](#)
[FI/term Search](#)
[PAJ](#)
[Design Gazette DB](#)
[Japanese Trademark Database](#)
[Japanese Figure Trademarks](#)

News

[News](#)

Link

[IPDL Links](#)

Questionnaire

[Questionnaire](#)

Notice



Please enable Cookie and JavaScript of the browser when you use the Industrial Property Digital Library.

✉ helpdesk@ipdl.inpit.go.jp

Copyright (C); 1999-2009 JPO and INPIT

Periférico Sur #3106 Col. Jardines del Pedregal
C.P. 01900, México, D.F.



• Inquiry

Click "FI" or "F-term". Or input FI / F-term code to the query box and click Search button.

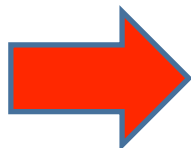

Query

Search Object

- [FI](#)

a61g7/02

Search

e.g. : A61K A61K6 C08L27/06 A61K7/46@A A61K7/46,315@A

- [F-term](#)

Search

F-term List F-term Description

e.g. : 2B 2B396

Indication type selection is effective in the lower hierarchies than the FI main group.

Indication Type List Target The same hierarchy

• Inquiry

Click "FI" or "F-term". Or input FI / F-term code to the query box and click Search button.

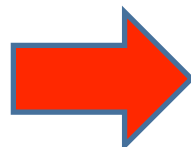

Query

Search Object

- [FI](#)

Search

e.g. : A61K A61K6 C08L27/06 A61K7/46@A A61K7/46,315@A

- [F-term](#)

4C040

Search

F-term List F-term Description

e.g. : 2B 2B396

Indication type selection is effective in the lower hierarchies than the FI main group.

Indication Type List Target The same hierarchy



GOBIERNO FEDERAL

SE



MÉXICO 2010

Bicentenario Independencia Centenario Revolución

MENU

HELP

TOP BACK NEXT

** F-term List **

This screen shows the F-term list of the theme "4C040".



4C040	Invalid beds and related equipment
	A61G7/00-7/10

Viewpoint	F-term										FI Cover Range	
AA	AA00	AA01		AA03	AA04	AA05	AA06		AA08		AA10	A61G7/00-7/10
	PURPOSE OR FUNCTIONS	. Prevention of bedsores		. Changing of body position	. . Shifting of the sleeping position	. . Getting up or down, or sitting	. . Standing		. Getting on or off, loading or unloading, or movement of the patient		. Use of sounds or lights so as to promote sleep	
		AA11	AA12	AA13	AA14			AA17	AA18	AA19		
		. Adaptations for use with toilets	. Sleep preparation (e.g., washing of the body or face or brushing of teeth)	. Bathing	. Changing of clothes			. Patient diagnosis or measurement	. . Medical monitoring	. . Weight measurement		
		AA21	AA22	AA23	AA24		AA26	AA27	AA28	AA29	AA30	
		. Cures or treatments	. . Electric or magnetic treatments	. . Physical straightening, traction, or training	. . Massage or finger-pressure (shiatsu) therapy		. Sterilization or disinfecting of the bed	. Deodorization	. Bed traveling and movement	. . Air conditioning, dehumidification, or ventilation	. Others	
BB	BB00	BB01	BB02	BB03			BB06					



	ADJUSTABLE OR MOVABLE BEDS	. Elevation	. . Partial elevation	. Longitudinal inclination	. . Partial inclination (i.e., raising the back unit)	. . . Bending (i.e., raising of the back and knee units)	. Lateral inclination	. . Partial lateral inclination	. Reciprocation	. Horizontal movement or rotation	. Others (e.g., reverse motion)
EE	EE00	EE01	EE02	EE03	EE04	EE05			EE08		
	DRIVE MECHANISMS OR CONTROL THEREOF	. Drive mechanisms	. . Compressed air	. . Oil pressure	. . Manual	. . Motorized			. Controls		
FF	FF00	FF01		FF03	FF04	FF05	FF06		FF08		
	AUXILIARY EQUIPMENT FOR EVACUATION OF BLADDER OR BOWELS	. Invalid-support units		. Movable invalid-support units with hole openings	. . Removable types	. . Opening-and-closing types	. . . Types that respond to rising or falling movement of the invalid-support unit		. Postures for easy evacuation of bladder or bowels		
		FF11	FF12		FF14	FF15		FF17		FF19	FF20
		. Toilet-bowl structures	. . Toilet seats or body-contact units		. Toilet units that are inserted by hand	. . Movement mechanisms		. Treatments after urination or defecation (e.g., cleaning, flushing, or deodorizing)		. Auxiliary bladder- or bowel-evacuation means for chairs or wheelchairs	. Others
GG	GG00	GG01	GG02	GG03	GG04	GG05	GG06	GG07	GG08	GG09	GG10
	ACCESSORIES OR AUXILIARY EQUIPMENT	. Sheets	. . Movable sheets or related devices	. Body-support devices (e.g., round seats, ..)	. Body-fastening devices (e.g., ..)	. Covers (e.g., blankets or bedspreads)	. Covers	. Cradles	. . Adjustable or movable cradles	. Rails	. . Adjustable or movable rails



**GOBIERNO
FEDERAL**

SE



MÉXICO 2010

Bicentenario Independencia
Centenario Revolución

www.impi.gob.mx

Periférico Sur #3106 Col. Jardines del Pedregal
C.P. 01900, México, D.F.



GOBIERNO FEDERAL

SE



MÉXICO 2010

Bicentenario Independencia Centenario Revolución

SIGA



Instituto Mexicano de la Propiedad Industrial

www.impi.gob.mx

Hoy es Martes, 16 de Febrero de 2010

Inicio | Preguntas Frecuentes | Mapa de Sitio | RSS | Contacto

Usted esta en: Inicio

Buscar en SIGA

SE

SIGA
e-gaceta

Sistema de Información de la Gaceta de la Propiedad Industrial

¡BIENVENIDOS!

La **Gaceta de la Propiedad Industrial** es el órgano de información oficial del **Instituto Mexicano de la Propiedad Industrial** mediante el cual se efectúa la publicación legal de los actos de autoridad y se difunde la información derivada de las patentes, registros, declaratorias de notoriedad o fama de marcas, autorizaciones y publicaciones concedidos y de cualesquiera otras referentes a los derechos de propiedad industrial que le confiere el Estado Mexicano en sus artículos 6o. fracción X y 8o. de la Ley de la Propiedad Industrial.

El **SIGA** es el Portal Oficial de la Gaceta de la Propiedad Industrial para la puesta en circulación, consulta y descarga electrónica de la Gaceta de la Propiedad Industrial en todos sus volúmenes, de conformidad con el artículo 15o. fracción VII del Reglamento del Instituto Mexicano de la Propiedad Industrial; y pone a disposición de todos aquellos interesados en la propiedad industrial la colección histórica de 136 años de los ejemplares la Gaceta de la Propiedad Industrial en formato PDF, así como los acervos de información publicada desde 1873 a la fecha sobre patentes, marcas y asuntos contenciosos.

La **Honorable Junta de Gobierno del IMPI** mediante **Acuerdo No. 35/2008/3a** establece que con fundamento en los artículos 9 fracción I del Decreto por el que se crea el Instituto Mexicano de la Propiedad industrial, y 58 fracción III de la Ley Federal de las Entidades Paraestatales, se aprueba la prestación de servicios de manera pública y gratuita por Internet del Portal de la Gaceta de la Propiedad Industrial denominado **SIGA**, sin afectar la producción, venta y distribución del correspondiente medio impreso en los términos y condiciones vigentes en la tarifa del Instituto.

MENÚ PRINCIPAL

- CONTENIDO
- AVISO DE PUESTA EN CIRCULACIÓN
- BÚSQUEDAS
- GUÍA DE USUARIO
- PREGUNTAS FRECUENTES
- TÉRMINOS Y CONDICIONES DE USO
- ACERCA DEL SIGA

TEMAS DE INTERÉS

- ViDoc - Visor de documentos
- CLASNIZA - Clasificador de Niza
- Vínculos relacionados
- Procedimiento de venta
- Tarifa
- RSS

SESIÓN

Usuario:

Contraseña:

Aceptar

Crear Cuenta

¿Olvidó su contraseña? Ayuda

- Mis consultas
- Estrategias de búsqueda
- Agregar a mis estrategias

MARQUETINA

¿Sabías que... ?

-Fuente SIGA-

Inicio | Mapa del Sitio | Contacto | RSS | Términos y condiciones de uso

Periférico Sur #3106 Col. Jardines del Pedregal C.P. 01900 México, D.F. Tels: 5334 0700 | 01800 57 05990 buzon@impi.gob.mx Arenal #550, Col. Pueblo Santa María Tepepan, CP 16020, México, D.F. Tel. Desde el Interior de la República 01800 57 05990

Periférico Sur #3106 Col. Jardines del Pedregal C.P. 01900, México, D.F.



GOBIERNO FEDERAL

SE



MÉXICO 2010

Bicentenario Independencia Centenario Revolución

www.impi.gob.mx

Inicio | Preguntas Frecuentes | Mapa de Sitio | RSS | Contacto

SE

Hoy es Martes, 16 de Febrero de 2010



Sistema de Información de la Gaceta de la Propiedad Industrial

Usted esta en: Inicio | Búsquedas | Búsquedas

Buscar en SIGA

Buscar

Búsqueda simple

MENÚ PRINCIPAL

- CONTENIDO
- AVISO DE PUESTA EN CIRCULACIÓN
- BÚSQUEDAS
- GUÍA DE USUARIO
- PREGUNTAS FRECUENTES
- TÉRMINOS Y CONDICIONES DE USO
- ACERCA DEL SIGA

TEMAS DE INTERÉS

- › ViDoc - Visor de documentos
- › CLASNIZA - Clasificador de Niza
- › Vínculos relacionados
- › Procedimiento de venta
- › Tarifa
- › RSS

Búsqueda avanzada | Búsqueda estructurada | Búsqueda por ejemplar

Resultados

Gaceta



- Todas
- Marcas
- Solicitudes de Patente
- Patentes

Buscar Por (máx. 256 caracteres):

a61g cama hospital

Resultados deben contener

La frase exacta

Ayuda

Buscar

SESIÓN

Usuario:

Contraseña:

Aceptar

Crear Cuenta

¿Olvidó su contraseña? Ayuda

- Mis consultas
- Estrategias de búsqueda
- Agregar a mis estrategias

MARQUESINA

¿Sabías que... ?

-Fuente SIGA-

Periférico Sur #3106 Col. Jardines del Pedregal
C.P. 01900, México, D.F.



1	Gaceta: Solicitudes de Patente	Volumen de: agosto 2008	Sección: Solicitudes PCT
	Ver detalle de la Ficha		Agregar <input type="checkbox"/>
	Número de solicitud: MX/A/2008/010419		
	Título: CAMA DE HOSPITAL TENIENDO UNA RUEDA SUPLEMENTARIA ...		
	Resumen: LA INVENCION SE RELACIONA CON UNA CAMA (3) DE HOSP...		
	Coincidencias: A61G7/08(2006.01)		
2	Gaceta: Solicitudes de Patente	Volumen de: enero 2007	Sección: Solicitudes PCT
	Ver detalle de la Ficha		Agregar <input type="checkbox"/>
	Número de solicitud: PA/A/2006/004922		
	Título: DISPOSITIVO MANIOBRABLE PARA TRANSPORTAR CARGAS SO...		
	Resumen: UN DISPOSITIVO MANIOBRABLE PARA TRANSPORTAR UNA CA...		
	Coincidencias: A61G1/02 ; A61G7/08		
3	Gaceta: Patentes	Volumen de: septiembre 2006	Sección: Patentes concedidas
	Ver detalle de la Ficha		Agregar <input type="checkbox"/>
	Número de solicitud: PA/A/2000/008107		
	Título: MONITOR DE PACIENTES EN CAMA A BASE DE MICROPROCES...		
	Resumen: ESTA INVENCION SE REFIERE EN GENERAL A SISTEMAS DE...		
	Coincidencias: A61G12/00 ; G08B21/00 ; A61G12/00 ; G08B21/00 ;		
4	Gaceta: Patentes	Volumen de: septiembre 2005	Sección: Patentes concedidas
	Ver detalle de la Ficha		Agregar <input type="checkbox"/>
	Número de solicitud: PA/A/2001/005893		
	Título: MECANISMO PARA CAMA DE HOSPITAL.		
	Resumen: UN MECANISMO PARA SUBIR Y BAJAR LA ALTURA DE UNA S...		
	Coincidencias: A61G7/00 ;		
5	Gaceta: Solicitudes de Patente	Volumen de: enero 2005	Sección: Solicitudes PCT
	Ver detalle de la Ficha		Agregar <input type="checkbox"/>
	Título: MONITOR DE PACIENTES EN CAMA A BASE DE MICROPROCES...		
	Resumen: ESTA INVENCION SE REFIERE EN GENERAL A SISTEMAS DE...		
	Número de solicitud: PA/A/2000/008107		
	Coincidencias: A61G12/00 ; G08B21/00		
6	Gaceta: Solicitudes de Patente	Volumen de: diciembre 2004	Sección: Solicitudes PCT
	Ver detalle de la Ficha		Agregar <input type="checkbox"/>
	Número de solicitud: PA/A/2002/008926		
	Título: CARRIL LATERAL DE CAMA,		
	Resumen: LA PRESENTE INVENCION SE REFIERE A UNA CAMA, Y PAR...		
	Coincidencias: A61G7/00		
7	Gaceta: Solicitudes de Patente	Volumen de: octubre 2004	Sección: Solicitudes PCT
	Ver detalle de la Ficha		Agregar <input type="checkbox"/>
	Número de solicitud: PA/A/2002/009220		



GOBIERNO
FEDERAL

SE



MÉXICO 2010

Bicentenario Independencia
Centenario Revolución

PYMETEC

Inicio

Búsqueda

Preguntas frecuentes

Foros

Sitios de interes

Apoyo a empresas



RECONOCIMIENTO

I N N O V A
2 0 0 6

La Secretaría de Economía y el IMPI, le damos la más cordial bienvenida al Portal de Tecnologías de Patentes para las Pequeñas y Medianas Empresas, PYMETEC, donde podrá encontrar una gran cantidad de información en todos los campos técnicos del conocimiento, la cual puede constituirse en una solución para su empresa que le ayudará a modernizar su negocio e incrementar su productividad.

Además de la información técnica que usted aquí encontrará, le proporcionaremos una serie de servicios y sitios de interés, así como asesoría especializada que le ayudarán a alcanzar los objetivos propuestos.

Si requiere de mayor información le agradeceremos ponerse en contacto con el Centro de Información Tecnológica (CIT) de la Dirección Divisional de Promoción y Servicios de Información Tecnológica en: pymetec@impi.gob.mx

AVISOS

Periférico Sur #3106 Col. Jardines del Pedregal
C.P. 01900, México, D.F.



**GOBIERNO
FEDERAL**

SE



MÉXICO 2010

Bicentenario Independencia
Centenario Revolución



Pyme



Inicio

Búsqueda

Preguntas frecuentes

Foros

Sitios de interes

Apoyo a empresas

Búsqueda simple

Búsqueda jerárquica por clasificación

Localización en campos de la ficha

Búsqueda avanzada

Canasta de mis patentes

Ayuda

Búsqueda avanzada

Expresión a buscar:

Puede usar paréntesis y operadores lógicos.

Los operadores que puede usar son:

- + (signo de más) conjunción (AND)
- / (diagonal) disyunción (OR)
- (signo de menos) conjunción negada (AND NOT)

Los términos a buscar pueden estar en Inglés o francés

Puede prefijar alguna(s) palabras con:

- ET: para título en inglés
- AB: para resumen en inglés
- FT: para título en francés
- AF: para resumen en francés
- INV: para inventores
- PA: para solicitante

Por ejemplo: ET:CHAIN + (DEVICE / METHOD)

heart + valve + leaflet

Buscar

Limpiar



**GOBIERNO
FEDERAL**

SE



MÉXICO 2010

Bicentenario Independencia
Centenario Revolución



Inicio

Búsqueda

Preguntas frecuentes

Foros

Sitios de interes

Apoyo a empresas

Búsqueda
simple

Búsqueda jerárquica
por clasificación

Localización en campos
de la ficha

Búsqueda
avanzada

Canasta de mis patentes

Ayuda

Número de publicación internacional (PN)	Título en inglés (ET)	
MXPA03002317 A 2005-09-15	PROSTHETIC MITRAL HEART VALVE.	<input type="checkbox"/>
WO2005076973 A2 2005-08-25	TRANSCATHETER DELIVERY OF A REPLACEMENT HEART VALVE	<input type="checkbox"/>
WO2005072654 A1 2005-08-11	ANATOMICALLY APPROXIMATE PROSTHETIC MITRAL HEART VALVE	<input type="checkbox"/>
WO2005069850 A2 2005-08-04	SUSPENDED HEART VALVE DEVICES, SYSTEMS, AND METHODS FOR SUPPLEMENTING, REPAIRING, OR REPLACING A NATIVE HEART VALVE	<input type="checkbox"/>
WO2005039428 A2 2005-05-06	HEART VALVE LEAFLET LOCATOR	<input checked="" type="checkbox"/>
WO2005009285 A2 2005-02-03	PERCUTANEOUS HEART VALVE	<input type="checkbox"/>
WO2005007036 A1 2005-01-27	A DEVICE FOR CORRECTING INVERSION OF THE LEAFLETS OF A LEAFLET VALVE IN THE HEART	<input type="checkbox"/>

Periférico Sur #3106 Col. Jardines del Pedregal
C.P. 01900, México, D.F.



**GOBIERNO
FEDERAL**

SE



MÉXICO 2010

Bicentenario Independencia
Centenario Revolución



FOCO AMARILLO :TECNOLOGÍA SUSCEPTIBLE DE LIBRE USO

Para verificar consulte:

1.-Banapa

2.- Solicite una búsqueda bibliográfica al IMPI

El sitio para los servicios electrónicos es: <http://eservicios.impi.gob.mx>.

Número de publicación(PN)	WO2005039428 A2 Más información	Fecha de publicación internacional	2005-05-06
Clasificaciones	MC: A 61 B 19/0 ICAA: A 61 B 17/00 (2006.01) ICAI: A 61 B 19/00 (2006.01) ICCA: A 61 B 17/00 (2006.01) ICCI: A 61 B 19/00 (2006.01)	Solicitantes	EDWARDS LIFESCIENCES AG LAN, Jan
Número de solicitud internacional (AN)	PCT EP 04011828	<i>Inventores (INV)</i>	LAN, Jan
Fecha de presentación internacional	2004-10-18	<i>Prioridad (PR)</i>	US 10/668,712 2003-10-17
Países designados (DS)	AE AE AG AL AL AM AM AM AT AT AU AZ AZ BA BB BG BG BR BR BW BY BY BZ BZ CA CH CN CN CO CO CR CR CU CU CZ CZ DE DE DK DK DM DZ EC EC EE EE EG EG ES ES FI FI GB GD GE GE GH GM HR HR HU HU ID IL IN IS JP JP KE KE KG KG KP KP KR KR KZ KZ LC LK LR LS LS LT LU LV MA MD MD MG MK MN MW MX MX MZ MZ NA NI NI NO NZ OM PG PH PH PL PL PT PT RO RU RU SC SD SE SG SK SK SL SL SY TJ TJ TM TM TN TR TR TT TT TZ UA UA UG UG US UZ UZ VC VN YU YU ZA ZM ZW BW GH GM KE LS MW MZ NA SD SL SZ TZ UG ZM ZW AM AZ BY KG KZ MD RU TJ TM		

GRACIAS POR SU ATENCIÓN

Ing. Leonardo Gómez Bautista

E-mail: lgomez@impi.gob.mx